

Enter



CHOSEN

THE BEST MATERIAL
SUPPLY SOURCES !

CHOSEN Applied Material Co., Ltd

Company Profile

- Founded at 1998
- Business Area
 - Bearings
 - Harmonic Drive Reducer
 - Spare Parts
- Employee : Office:8 , Factory:30

About the process

專業 品質 服務 創新，為子申應用材料的核心理念，也是我們與其他廠商的優勢差異。

1. 客戶溝通研討之後我們會在三天內做出應對方案回復
2. 材料選擇
3. 進料檢驗
4. 生產排程
5. 粗胚加工
6. 熱處理
7. 精加工
8. 超精加工
9. 表面處理、清潔
10. 尺寸檢驗
11. 運轉測試
12. 清潔包裝出廠

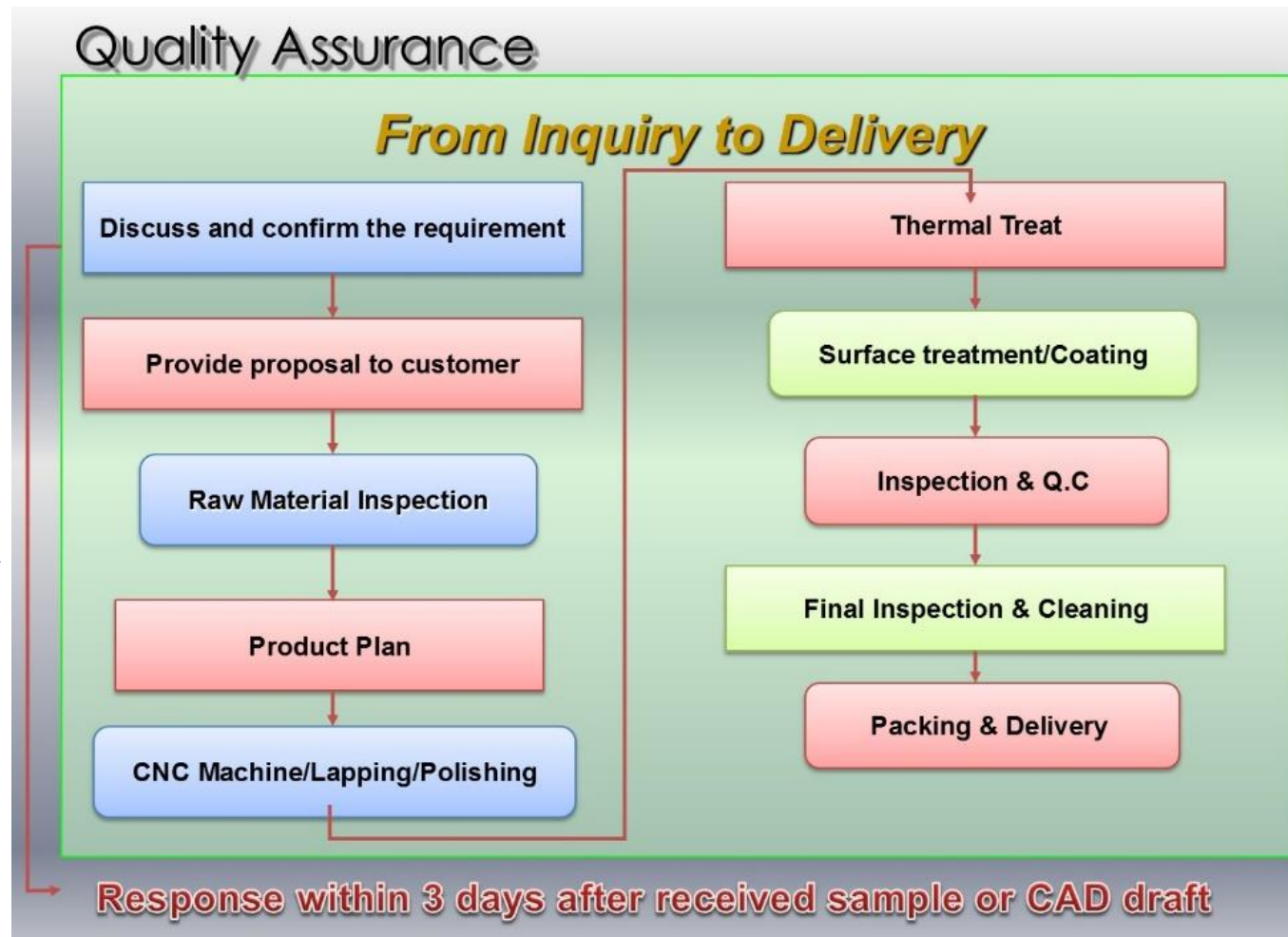

OEM/ODM Fab and Factory

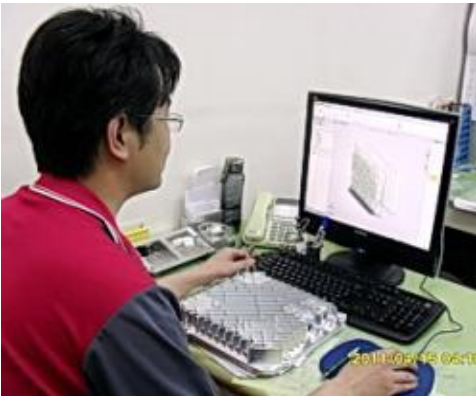

About the process



粗胚件車銑加工



精密滾齒機



精密滾齒機



滾齒加工



插齒加工

About the process



產品設計與改善



超精密掃描量測



3D尺寸量測

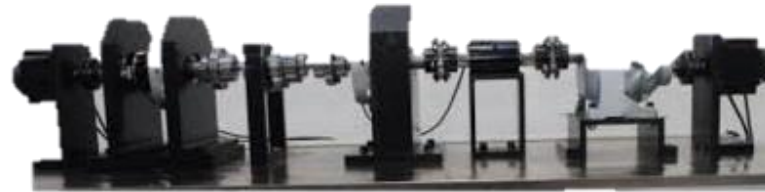

運轉精度測試



2D尺寸量測



清潔包裝出廠

Bearings



C.A.M.-pro



SIC JAPAN BEARINGS



IKO

MOTION & CONTROL™
NSK

Koyo®



FAG









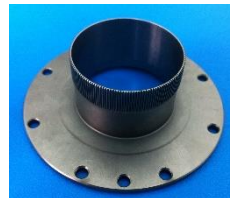
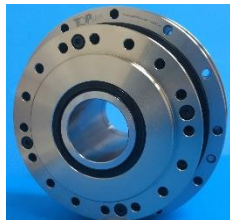
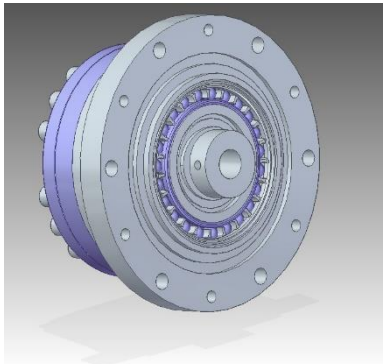
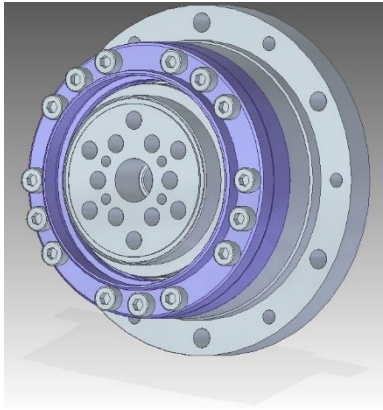



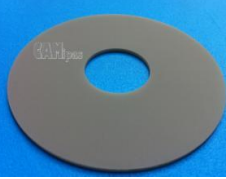



CHOSEN | THE BEST MATERIAL
SUPPLY SOURCES !
CHOSEN Applied Material Co., Ltd

Harmonic Drive Reducer





TOPdrive



Application in Semiconductor

Item	Module	Picture		
1	T/F, Diff			
2	CMP			
3	Etching			
4	Robot			
5	Bonding Stage			
6	Dry Etching			

Application in LCD, T/P

Item	Module	Picture			
1	PVD				
2	Etching				
3	Robot				
4	Oven				
5	Bonding Stage				

Application in LED



Pin Ring

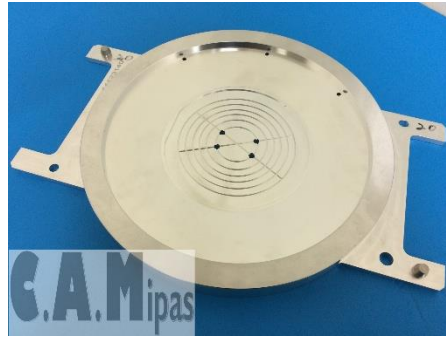

Wafer Stage



Robot Blade

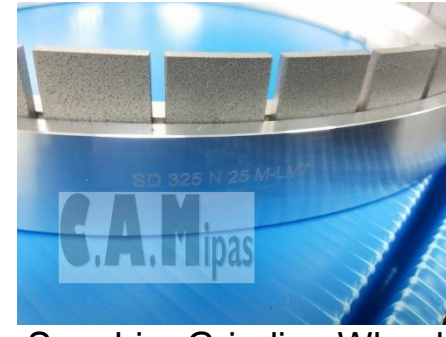

Sapphire Grinding Wheel



ALN Substrate



PVD Parts(Al₂O₃)



SUS Housing



Wafer Clamp



Heat Insulating Brick

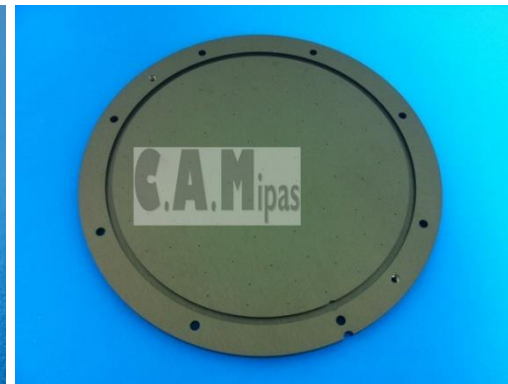

Shower Head

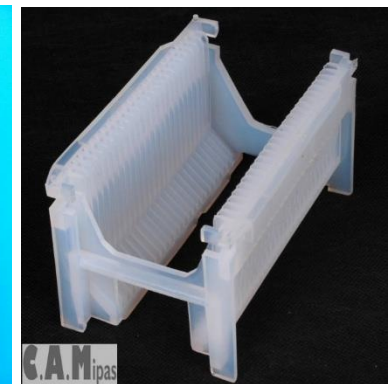

Wafer Cassette

Component For Mold & Die

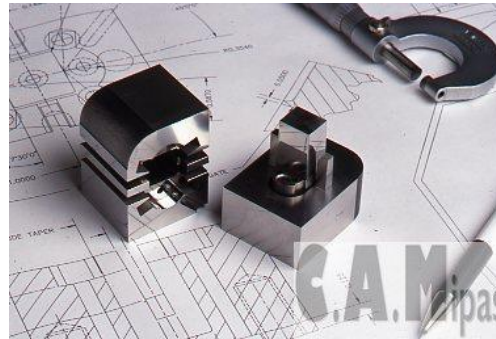

Reference

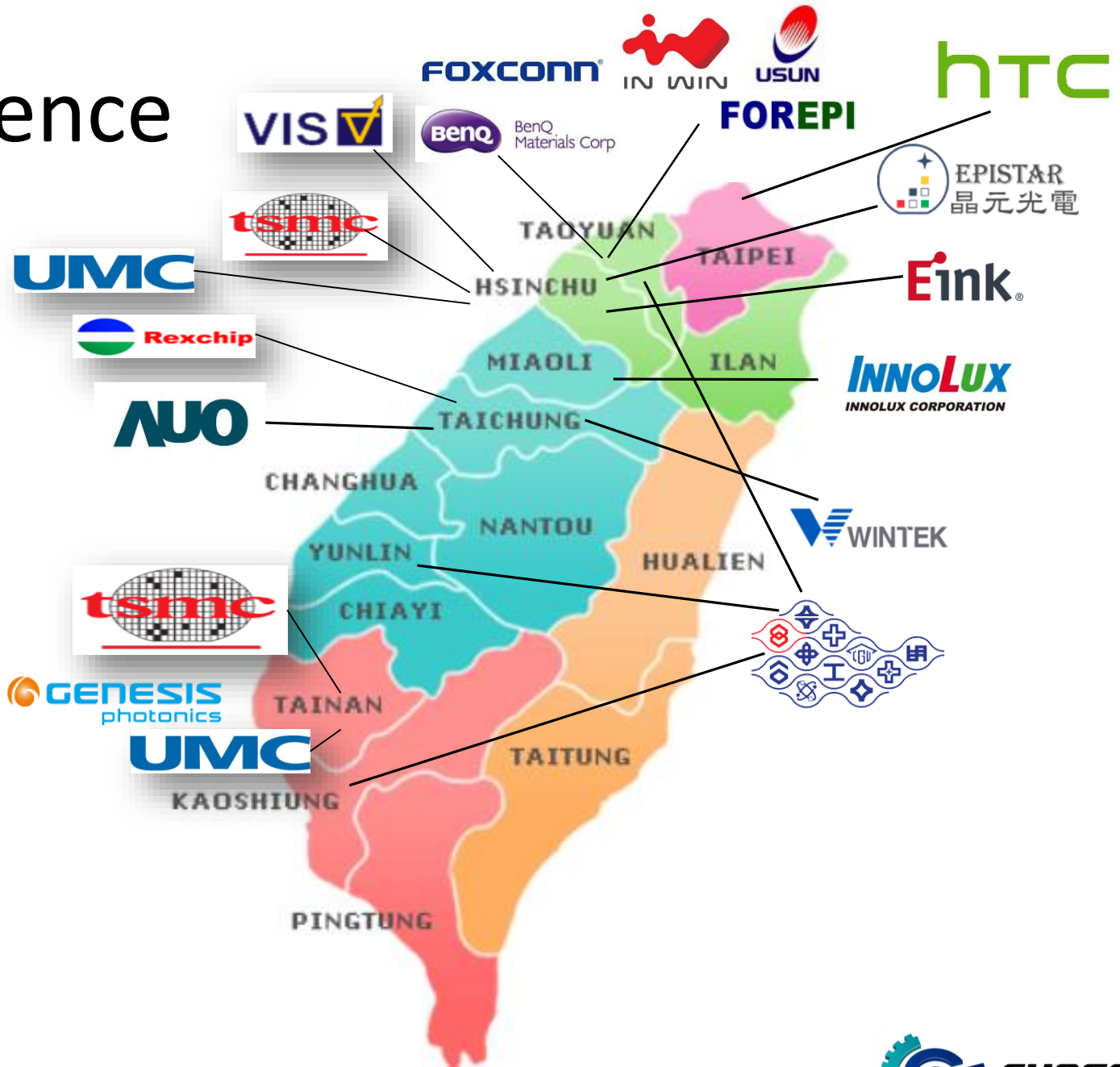

Vision

- Chosen Applied Material is focusing on **spare parts , mold, jig and components** which applied in Semiconductor , LED , LCD , T/P and Solar with high quality controlled machining process.
- Willing to provide **reverse engineering service, OEM & ODM** products.
- Through Continue Improvement Progress (CIP) with customer together to deliver on our commitments.
- Efficiency and Innovative.
- Win-Win solution with customer.

Q&A

Thank you for your time.

<http://www.chosen.tw>

TEL:+886-3-3375266 FAX:+886-3-3375466

Product Line:

Bearings: High Precision Bearings , Anti-Corrosion Anti-Chemical Bearings , High Temperature Bearings , Custom Bearings

TOPdrive: TSG , THG , TSD , THD series

Spare Parts: Device Components , Reverse Engineering , Automated Machining , Custom Machine , Tool & Die Building , Repair & Design



CHOSEN | THE BEST MATERIAL
SUPPLY SOURCES !
CHOSEN Applied Material Co., Ltd